

## Frequency Response

<Conditions> ● Hydraulic Circuit: Port A/B Closed ● Supply Pressure : 14 MPa

### ● LSVG-03EH-40-\*-\*-10 (Dry Type)

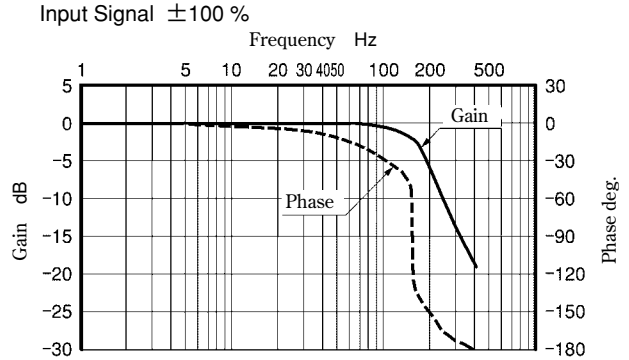
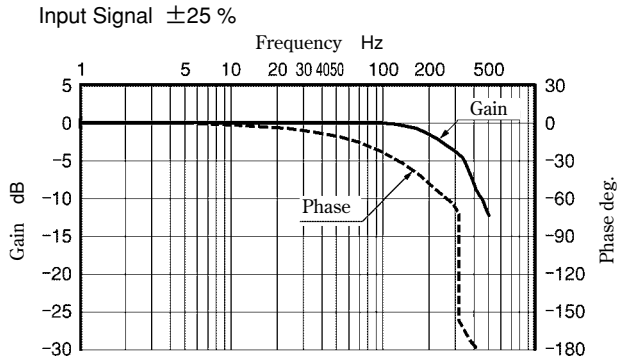

### ● LSVG-03EH-40-W-\*-\*-10 (Wet Type)

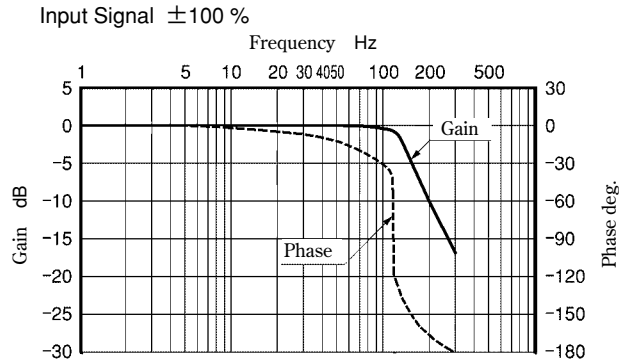
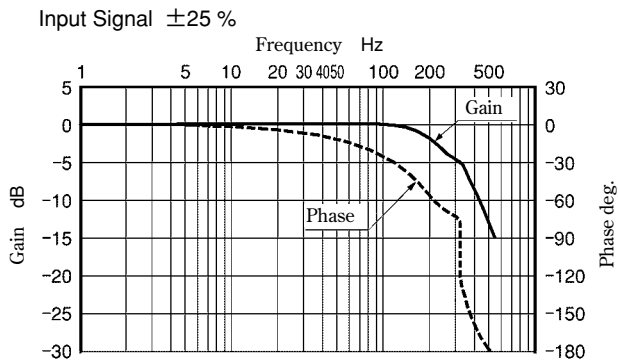

### ● LSVG-03EH-60-\*-\*-10 (Dry Type)

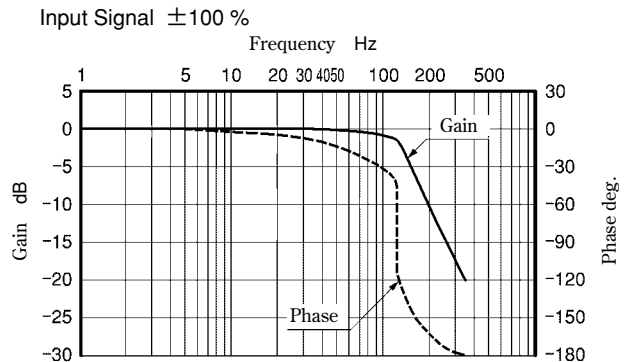
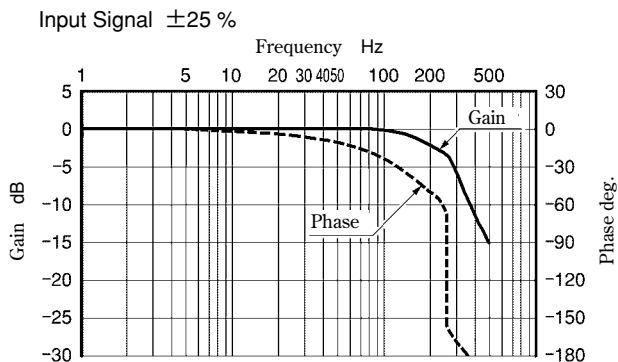

### ● LSVG-03EH-60-W-\*-\*-10 (Wet Type)

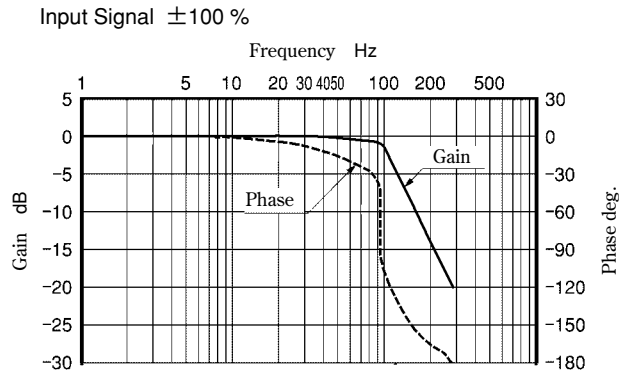
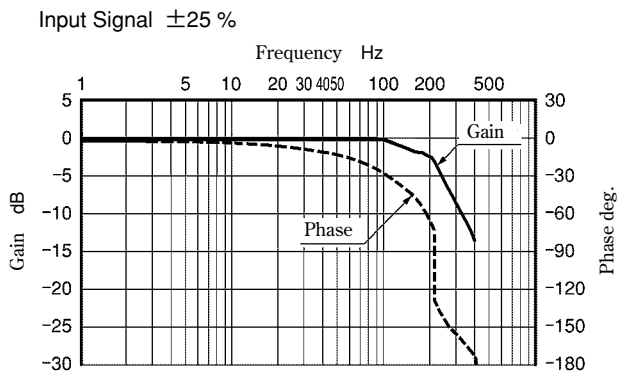

## OBE(On-Board Electronic) Type Linear Servo Valves (Std. Type)

On-board electronics (OBE) type linear servo valves have been developed based on two stage type high speed linear servo valves, but with a focus on downsizing the pilot valve. The integration of the exclusive amplifier and the linear servo valve in a compact package provides “high accuracy, easiness to use, and great usability”.

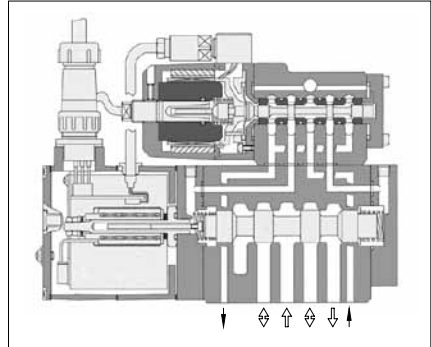
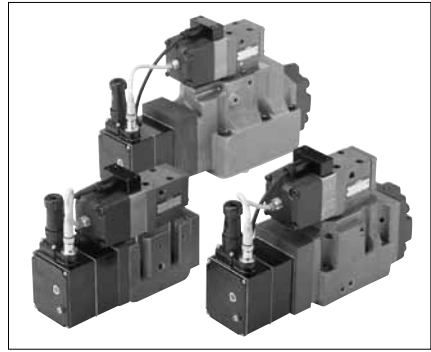

- High accuracy

As is the case with the high speed linear servo valves, all of the OBE type linear servo valves have a low hysteresis of 0.1 % or less, realizing high accuracy. These valves allow the main unit to operate with much higher repeatability.

- High response characteristics

Compared to other equivalent models, these valves provide higher levels of step and frequency responses, which are typically used as measures of response characteristics; the step response is 7 ms (0 <=> 100 %)★, and the frequency response is 125 Hz/-3 dB (± 25 % amplitude)★. (★ : Representative values for LSVHG-03EH)

- Easiness to use

These valves can offer high accuracy for hydraulic control systems just with 24 V DC power supply and command signal input.

Six types of input signals in three input voltage/current ranges are available: 0 - ±10 V, 0 - ±10 mA, and 4 - 20 mA.

- Great usability

The small amplifier in the valves has a fault indicator lamp. This lamp indicates an error when valve failure causes any deviation between the spool position commanded by the signal and the actual spool position. It facilitates you to immediately troubleshoot the failure of the valves, if any.

- Two types of pilot valves available

There are two types of pilot valves available: a dry type good in response characteristics and a wet type that eliminates the drain (DR) port to improve usability. They can be selected according to users' purposes.

- Excellent contamination resistance

As is the case with the high speed linear servo valves, the OBE type linear servo valves have a simple pilot valve structure, exhibiting excellent contamination resistance. The permissible level of fluid contamination for these valves is up to NAS 1638 class 10.

### Graphic Symbols

- Spool Types “2”, “2P”, and “2L”

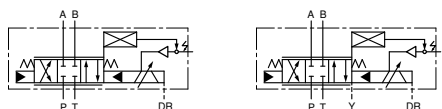

Int. Pilot - Int. Drain

Int. Pilot - Ext. Drain

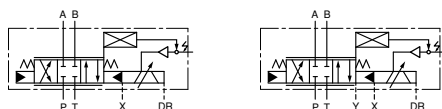

Ext. Pilot - Int. Drain

Ext. Pilot - Ext. Drain

- Spool Type “40”

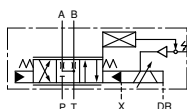

The symbols above indicate the external pilot/internal drain type. The internal pilot/internal drain type is the same as that for the spool types “2”, “2P”, and “2L”.

- Spool Type “4J”

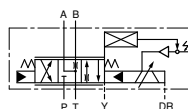

Input Signal/Spool Travel Monitoring “D”/“E”/“F”

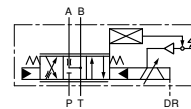

The pilot and drain types are the same as those for the input signal/spool travel monitoring “A”/“B”/“C”.

- Detailed Graphic Symbols (With Fail-safe Solenoid Operated Valve)

LSVHG-03/04EH-\*\*-EA/\*EB/\*EC

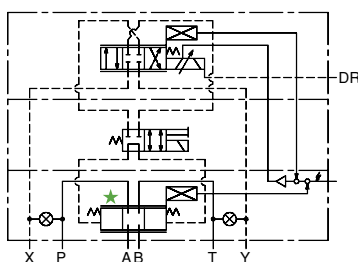

LSVHG-06/10EH-\*\*-EA/\*EB/\*EC

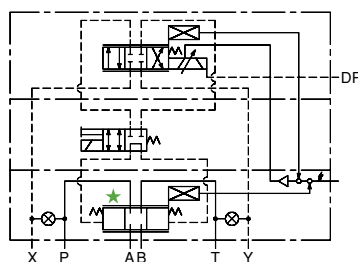

⊗ : Plugs for selecting the pilot and drain types

★ : Depending on the spool type.  
(Same as the graphic symbols shown above)

## Model Number Designation

F-	LSVHG	-06	EH	-900	-2P	-E	T	-W	A	-A	1	-20				
Fluid Type	Series Number	Valve Size	Amp. Type	Rated Flow @ $\Delta P = 7 \text{ MPa}$	Spool Type <sup>*1 *5</sup>	Pilot Type	Drain Type	DR Port and Permissible Back Pres.	Fail-safe Function <sup>*1</sup>	Input Signal/Spool Travel Monitoring <sup>*1</sup>	Connector Type	Design Number				
F: Special Seals for Phosphate Ester Type Fluid (Omit if not required)	LSVHG: Two Stage Type Linear Servo Valves	03	EH: OBE Type	230: 230 L/min	2L	None: Internal Pilot	None: External Drain	None: With DR Port (Permissible Back Pres.: 0.05 MPa) (Dry Type Pilot Valve)	None: P→B→A→T Position Valve Opening: Full <b>A:</b> P→A→B→T Position Valve Opening: Full	A: Voltage Signal ±10 V (P→B→A→T Flow with Input Signal (+)) <b>B:</b> Current Signal 4 - 20 mA (P→B→A→T Flow with Current Signal 12 - 20 mA) <b>C:</b> Current Signal ±10 mA (P→B→A→T Flow with Input Signal (+)) <b>D:</b> Voltage Signal ±10 V (P→A→B→T Flow with Input Signal (+)) <b>E:</b> Current Signal 4 - 20 mA (P→A→B→T Flow with Current Signal 12 - 20 mA) <b>F:</b> Current Signal ±10 mA (P→A→B→T Flow with Input Signal (+))	1: PE Pole 2: <sup>*3</sup> PE Pole 11+ PE Pole	20				
				270: 270 L/min	2, 40, 2P											
				210: <sup>*4</sup> 210 L/min	4J: Open Centre A, B & T											
				750: 750 L/min	2L: 2% Overlap (Linear Flow Gain)											
				580: <sup>*4</sup> 580 L/min	4J: Open Centre A, B & T											
				900: 900 L/min 1300: 1300 L/min	2, 40, 2P 2L: 2% Overlap (Linear Flow Gain)											
		04	EH: OBE Type	06	820: <sup>*4</sup> 820 L/min				4J: Open Centre A, B & T	E: External Pilot			T: Internal Drain	W: <sup>*2</sup> Without DR Port (Wet Type Pilot Valve)	None: P→B→A→T Position Valve Opening: Full <b>A:</b> P→A→B→T Position Valve Opening: Full	None: P→B→A→T Position Valve Opening: Full <b>A:</b> P→A→B→T Position Valve Opening: Full
					820: <sup>*4</sup> 820 L/min				4J: Open Centre A, B & T							
					820: <sup>*4</sup> 820 L/min				4J: Open Centre A, B & T							
					820: <sup>*4</sup> 820 L/min				4J: Open Centre A, B & T							
					820: <sup>*4</sup> 820 L/min				4J: Open Centre A, B & T							
					820: <sup>*4</sup> 820 L/min				4J: Open Centre A, B & T							
10	EH: OBE Type	06	3800: 3800 L/min	2, 40, 2P 2L: 2% Overlap (Linear Flow Gain)	E: External Pilot	T: Internal Drain	W: <sup>*2</sup> Without DR Port (Wet Type Pilot Valve)	None: P→B→A→T Position Valve Opening: Full <b>A:</b> P→A→B→T Position Valve Opening: Full	None: P→B→A→T Position Valve Opening: Full <b>A:</b> P→A→B→T Position Valve Opening: Full							
			3800: 3800 L/min	2, 40, 2P 2L: 2% Overlap (Linear Flow Gain)												
			3800: 3800 L/min	2, 40, 2P 2L: 2% Overlap (Linear Flow Gain)												
			3800: 3800 L/min	2, 40, 2P 2L: 2% Overlap (Linear Flow Gain)												
			3800: 3800 L/min	2, 40, 2P 2L: 2% Overlap (Linear Flow Gain)												
			3800: 3800 L/min	2, 40, 2P 2L: 2% Overlap (Linear Flow Gain)												

- ★ 1. The available combinations of the spool type, fail-safe function, and input signal/spool travel monitoring are limited. For details, see the chart on the right.
- ★ 2. The valves with the model number "W" (without DR port) cannot use water-glycol fluids.
- ★ 3. For the valves with the fail-safe function "EC", select "2" only for the connector type.
- ★ 4. For the spool type "4J", the rated flow is a value obtained with +100% input and P → A flow (input signal/spool travel monitoring "A", "B", and "C") or P → B flow ("D", "E", and "F").
- ★ 5. For the spool function in the neutral position, see the chart below.

Spool Type	Fail-safe Function	Input Signal/Spool Travel Monitoring
2	With Solenoid Operated Valve: EC	All (A, B, C, D, E, F)
40	Without Solenoid Operated Valve: None/A	
2L	With Solenoid Operated Valve: EA/EB	
2P	Without Solenoid Operated Valve: None/A	
4J	With Solenoid Operated Valve: EC	D, E, F
	Without Solenoid Operated Valve: None	A, B, C
	Without Solenoid Operated Valve: A	

## Spool Function in Neutral Position

Spool Type	Function
2, 2P, 2L	
40	
4J	

## Fail-safe Function of the Valves

With reference to the information given below, select the option for the fail-safe function according to the use of applications. The valves have a fail-safe function, but a separate safety circuit should be provided if the hydraulic actuator must be reliably held or stopped to ensure safety in the event of electric failure (power failure, power cable disconnection, etc.) or upon startup.

1) Electric System: OFF and Hydraulic System: ON (Power Failure/Power Cable Disconnection)

No.	Model Number	Fail-safe Function <sup>*</sup>
1	(F-) LSVHG- * * EH- * -2/2P/2L (-E) (T) (-W)	P→B→A→T Position Valve Opening: Full
2	(F-) LSVHG- * * EH- * -2/2P/2L (-E) (T) (-W) A	P→A→B→T Position Valve Opening: Full
3	(F-) LSVHG- * * EH- * -4J (-E) (T) (-W)	P→B→A→T Position Valve Opening: Full
4	(F-) LSVHG- * * EH- * -4J (-E) (T) (-W) A	P→A→B→T Position Valve Opening: Full
5	(F-) LSVHG- * * EH- * -2/2P/2L (-E) (T) (-W) EA (With Fail-safe Solenoid Operated Valve)	P→A→B→T Position Valve Opening: 10 %
6	(F-) LSVHG- * * EH- * -2/2P/2L (-E) (T) (-W) EB (With Fail-safe Solenoid Operated Valve)	P→B→A→T Position Valve Opening: 10 %
7	(F-) LSVHG- * * EH- * -4J (-E) (T) (-W) EC-A * /B * /C * (With Fail-safe Solenoid Operated Valve)	A, B, T Connection (Neutral)
8	(F-) LSVHG- * * EH- * -4J (-E) (T) (-W) EC-D * /E * /F * (With Fail-safe Solenoid Operated Valve)	A, B, T Connection (Neutral)

★ The fail-safe activation time depends on the electric and hydraulic conditions.

2) Electric System: OFF and Hydraulic System: OFF (Startup)

For Models No. 1 and 2 in the table above, the fail-safe function holds the spool in the neutral position. For Models No. 5 and 6, the function is the same as that for "Electric System: OFF and Hydraulic System: ON". For Models No. 3, 4, 7, and 8, the function is based on A, B, T connection (neutral).

## Specifications

### LSVHG-\*EH-\* -2/40/2P/2L

The values in parentheses in the specification table below are applicable to the models "LSVHG-\*EH-\*-\*-\* -W\*-" (without DR port).

Description			Model Numbers		LSVHG-03EH-230-*	LSVHG-03EH-270-*	LSVHG-04EH-750-*	LSVHG-06EH-900-*	LSVHG-06EH-1300-*	LSVHG-10EH-3800-*																													
Spool Type			2 L		2	40	2P	2	40	2P	2 L	2	40	2P	2 L	2	40	2P	2 L																				
Rated Flow at $\Delta P = 7$ MPa (4-Way Valve) L/min			230		270		750		900		1300		3800																										
Rated Flow at $\Delta P' = 0.5$ MPa (per Land) L/min			87		102		283		340		490		1440																										
Max. Operating Pressure MPa			31.5		35		35		31.5		35																												
Proof Pres. at Return Port <sup>(1)</sup>	External Drain	T Port MPa	21 <sup>(5)</sup>		31.5		35		25		28																												
		Y Port MPa	21 (7) <sup>(5)</sup>		21 (7)		21 (7)		21 (7)																														
	Internal Drain	T & Y Port MPa	21 (7) <sup>(5)</sup>		21 (7)		21 (7)		21 (7)																														
DR Port Permissible Back Pressure <sup>(2)</sup> MPa			0.05 (The valves with the model number "W" have no DR port.)																																				
Pilot Pressure <sup>(3)</sup> MPa			1.5 - 21																																				
Pilot Flow Rate <sup>(4)</sup> L/min			9 (8) or more		20 (17) or more		22 (19) or more		23 (19) or more		28 (24) or more																												
Pilot Valve Max. Leakage	Pres.: $P_s = P_r = 14$ MPa	L/min	0.8		1.2																																		
			1.6		0.5		1		5.6		0.8		1.6		6.8		2.5		0.9		1.8		7		2.5		1		2		8		2.5		3		6		10
Main Valve Max. Leakage			Max. Leakage Viscosity: 32 mm <sup>2</sup> /s																																				
Hysteresis %			0.1 or less																																				
Step Response (0 <=> 100 %, Typical) <sup>(6)</sup> ms			8 (10)		7 (9)		11 (13)		11 (13)		15 (18)		18 (20)																										
Frequency Response ( $\pm 25$ % Amplitude, Typical) <sup>(6)</sup>	Gain: -3 dB	Hz	120 (100)		125 (110)		100 (90)		100 (90)		75 (70)		60 (55)																										
	Phase: -90°	Hz	110 (90)		110 (100)		90 (90)		90 (90)		70 (75)		70 (60)																										
Vibration Proof <sup>(7)</sup> m/s <sup>2</sup>			100																																				
Protection			IP 65																																				
Ambient Temperature °C			0 - +50																																				
Spool Stroke to Stops mm			$\pm 4$		$\pm 3.5$		$\pm 5$		$\pm 5$		$\pm 7$		$\pm 7$																										
Spool End Area cm <sup>2</sup>			3		7		8		8		11.3																												
Polarity			See the description about I/O signal characteristics on page 35.																																				
Linear Motor Specification	Current	A	Max. 2.1																																				
	Coil Resistance	$\Omega$	9.6 [at 20 °C]																																				
Approx. Mass <sup>(8)</sup> kg			8.5 [11]		14 [16]		20 [24]		20 [24]		77																												
Electric Connection			6 + PE/11 + PE Connector (EN175201 Part 804)																																				

Note: <sup>(1)</sup> Pressure at the return port should be at actual supply pressure or less.

<sup>(2)</sup> Back pressure at the drain port should be 0.05 MPa or less and not be a negative pressure.

<sup>(3)</sup> Supply pressure for the pilot valve should be 1.5 - 21 MPa and should also be 60 % of actual supply pressure or more.

<sup>(4)</sup> The pilot flow is calculated based on a pilot pressure of 14 MPa and the above step response.

<sup>(5)</sup> To use an external pilot type valve with a supply pressure of 21 MPa or more, pressures at the T and Y ports should be 7 MPa or less.

<sup>(6)</sup> This value is measured for each valve based on a pilot pressure of 14 MPa; it may vary depending on the actual circuit/operation conditions.

<sup>(7)</sup> There are restrictions on the mounting position; refer to the instructions for details.

<sup>(8)</sup> A value in brackets indicates the mass of each valve with a fail-safe solenoid operated valve.

<sup>(9)</sup> For the effective range of the fail-safe function, see page 59.

## Specifications

### LSVHG-\*EH-\*-4J-\*-A\*/B\*/C\*

The values in parentheses in the specification table below are applicable to the models “LSVHG-\*EH-\*-\*\*-\*EH-W\*-\*” (without DR port).

Description		Model Numbers	LSVHG-03EH-210 -4J-*-A*/B*/C*	LSVHG-04EH-580 -4J-*-A*/B*/C*	LSVHG-06EH-820 -4J-*-A*/B*/C*	LSVHG-06EH-1300 -4J-*-A*/B*/C*	
Spool Type		4J: Open Centre A, B & T P→B Flow: 10 % Overlap, A→T Flow: 50 % Underlap P→A Flow: 60 % Overlap, B→T Flow: 5 % Underlap					
Rated Flow (±10%)	ΔP = 3.5 MPa (per Land)	L/min	P→B Flow: 210 A→T Flow: 235 P→A Flow: 95 B→T Flow: 240	P→B Flow: 580 A→T Flow: 675 P→A Flow: 255 B→T Flow: 660	P→B Flow: 820 A→T Flow: 950 P→A Flow: 370 B→T Flow: 940	P→B Flow: 1300 A→T Flow: 1440 P→A Flow: 660 B→T Flow: 1375	
	ΔP = 0.5 MPa (per Land)	L/min	P→B Flow: 79 A→T Flow: 89 P→A Flow: 36 B→T Flow: 91	P→B Flow: 219 A→T Flow: 255 P→A Flow: 96 B→T Flow: 249	P→B Flow: 310 A→T Flow: 359 P→A Flow: 140 B→T Flow: 355	P→B Flow: 491 A→T Flow: 544 P→A Flow: 249 B→T Flow: 520	
Max. Operating Pressure		MPa	31.5	35	35	31.5	
Proof Pres. at Return Port <sup>(1)</sup>	External Drain	T Port	MPa	21	31.5	35	25
		Y Port	MPa	21 (7)			
Internal Drain	T & Y Ports	MPa		21 (7)			
DR Port Permissible Back Pressure <sup>(2)</sup>		MPa	0.05 or less (The valves with the model number “W” have no DR port.)				
Pilot Pressure <sup>(3)</sup>		MPa	1.5 - 21				
Pilot Flow Rate <sup>(4)</sup>		L/min	9 (8) or more	20 (17) or more	22 (19) or more	23 (19) or more	
Pilot Valve Max. Leakage	Pres.: P <sub>s</sub> = P <sub>p</sub> = 14 MPa Max. Leakage Viscosity: 32 mm <sup>2</sup> /s	L/min	0.8 or less	1.2 or less	1.2 or less		
Main Valve Max. Leakage			0.7 or less	1.1 or less	1.2 or less		
Hysteresis		%	0.1 or less				
Step Response (0 <=> 100 %) P <sub>p</sub> = 14 MPa (Typical) <sup>(5)</sup>		ms	7 (9)	11 (13)	11 (13)	15 (18)	
Frequency Response (±25 % Amplitude) P <sub>p</sub> = 14 MPa (Typical) <sup>(5)</sup>		Hz	Gain = -3 dB: 125 (110) Phase = -90° : 110 (100)	Gain = -3 dB: 100 (90) Phase = -90° : 90 (90)	Gain = -3 dB: 100 (90) Phase = -90° : 90 (90)	Gain = -3 dB: 75 (70) Phase = -90° : 70 (75)	
Vibration Proof		m/s <sup>2</sup>	100				
Protection			IP 65				
Ambient Temperature		°C	0 - +50				
Spool Stroke to Stops		mm	±3.5	±5	±5	±7	
Spool End Area		cm <sup>2</sup>	3	7	8	8	
Polarity			See the description about I/O signal characteristics on page 35.				
Linear Motor Specification	Current	A	Max. 2.1				
	Coil Resistance	Ω	9.6 [at 20 °C]				
Approx. Mass <sup>(6)</sup>		kg	8.5 [11]	14 [16]	20 [24]		
Electric Connection			6 + PE/11 + PE Connector 【EN175201 Part 804】				

Note: (1) Pressure at the return port should be at actual supply pressure or less (to use an external pilot type valve with the size “03” at 21 MPa or more, pressures at the T and Y ports should be 7 MPa or less).

(2) Back pressure at the drain port should be 0.05 MPa or less and not be a negative pressure.

(3) Supply pressure for the pilot valve should be 1.5 - 21 MPa and should also be 60 % of actual supply pressure or more.

(4) The pilot flow is calculated based on a pilot pressure of 14 MPa and the above step response.

(5) This value is measured for each valve based on a pilot pressure of 14 MPa; it may vary depending on the actual circuit/operation conditions.

(6) A value in brackets indicates the mass of each valve with a fail-safe solenoid operated valve.

(7) For the effective range of the fail-safe function, see page 59.

# Linear Servo Valves

## Specifications

### LSVHG-\*EH-\*-4J-\*-D\*/E\*/F\*

The values in parentheses in the specification table below are applicable to the models “LSVHG-\*EH-\*-\*\*EH-W\*-\*” (without DR port).

Model Numbers		LSVHG-03EH-210	LSVHG-04EH-580	LSVHG-06EH-820	LSVHG-06EH-1300		
Description		-4J-*-D*/E*/F*	-4J-*-D*/E*/F*	-4J-*-D*/E*/F*	-4J-*-D*/E*/F*		
Spool Type		4J: Open Centre A, B & T P→A Flow: 10 % Overlap, B→T Flow: 50 % Underlap P→B Flow: 60 % Overlap, A→T Flow: 5 % Underlap					
Rated Flow (±10%)	Δ P = 3.5 MPa (per Land)	L/min	P→A Flow: 210 B→T Flow: 235 P→B Flow: 95 A→T Flow: 240	P→A Flow: 580 B→T Flow: 675 P→B Flow: 255 A→T Flow: 660	P→A Flow: 820 B→T Flow: 950 P→B Flow: 370 A→T Flow: 940	P→A Flow: 1300 B→T Flow: 1440 P→B Flow: 660 A→T Flow: 1375	
	Δ P = 0.5 MPa (per Land)	L/min	P→A Flow: 79 B→T Flow: 89 P→B Flow: 36 A→T Flow: 91	P→A Flow: 219 B→T Flow: 255 P→B Flow: 96 A→T Flow: 249	P→A Flow: 310 B→T Flow: 359 P→B Flow: 140 A→T Flow: 355	P→A Flow: 491 B→T Flow: 544 P→B Flow: 249 A→T Flow: 520	
Max. Operating Pressure		MPa	31.5	35	35	31.5	
Proof Pres. at Return Port (1)	External Drain	T Port	MPa	21	31.5	35	25
		Y Port	MPa	21 (7)			
	Internal Drain	T & Y Ports	MPa	21 (7)			
DR Port Permissible Back Pressure (2)		MPa	0.05 or less (The valves with the model number “W” have no DR port.)				
Pilot Pressure (3)		MPa	1.5 - 21				
Pilot Flow Rate (4)		L/min	9 (8) or more	20 (17) or more	22 (19) or more	23 (19) or more	
Pilot Valve Max. Leakage	Pres.: PS = PP = 14 MPa Max. Leakage Viscosity: 32 mm <sup>2</sup> /s	L/min	0.8 or less	1.2 or less	1.2 or less		
Main Valve Max. Leakage			0.7 or less	1.1 or less	1.2 or less		
Hysteresis		%	0.1 or less				
Step Response (0 <=> 100 %) P <sub>p</sub> = 14 MPa (Typical) (5)		ms	7 (9)	11 (13)	11 (13)	15 (18)	
Frequency Response (± 25 % Amplitude) P <sub>p</sub> = 14 MPa (Typical) (5)		Hz	Gain = -3 dB: 125 (110) Phase = -90° : 110 (100)	Gain = -3 dB: 100 (90) Phase = -90° : 90 (90)	Gain = -3 dB: 100 (90) Phase = -90° : 90 (90)	Gain = -3 dB: 75 (70) Phase = -90° : 70 (75)	
Vibration Proof		m/s <sup>2</sup>	100				
Protection			IP 65				
Ambient Temperature		°C	0 - +50				
Spool Stroke to Stops		mm	±3.5	±5	±5	±7	
Spool End Area		cm <sup>2</sup>	3	7	8	8	
Polarity			See the description about I/O signal characteristics on page 35.				
Linear Motor Specification	Current	A	Max. 2.1				
	Coil Resistance	Ω	9.6 [at 20 °C]				
Approx. Mass (6)		kg	8.5 [11]	14 [16]	20 [24]		
Electric Connection			6 + PE/11 + PE Connector 【EN175201 Part 804】				

Note: (1) Pressure at the return port should be at actual supply pressure or less (to use an external pilot type valve with the size “03” at 21 MPa or more, pressures at the T and Y ports should be 7 MPa or less).

(2) Back pressure at the drain port should be 0.05 MPa or less and not be a negative pressure.

(3) Supply pressure for the pilot valve should be 1.5 - 21 MPa and should also be 60 % of actual supply pressure or more.

(4) The pilot flow is calculated based on a pilot pressure of 14 MPa and the above step response.

(5) This value is measured for each valve based on a pilot pressure of 14 MPa; it may vary depending on the actual circuit/operation conditions.

(6) A value in brackets indicates the mass of each valve with a fail-safe solenoid operated valve.

(7) For the effective range of the fail-safe function, see page 59.

## Attachment

### Mounting Bolt

Model Number	Mounting Bolt	Qty.	Bolt Tightening Torque
LSVHG-03EH	Hex. Soc. Head Cap Screw : M6×35L	4	12.9 - 15.9 Nm
LSVHG-04EH	Hex. Soc. Head Cap Screw : M6×55L	2	12.9 - 15.9 Nm
	Hex. Soc. Head Cap Screw : M10×60L	4	60.6 - 74.1 Nm
LSVHG-06EH	Hex. Soc. Head Cap Screw : M12×85L	6	104 - 127 Nm
LSVHG-10EH	Hex. Soc. Head Cap Screw : M20×90L	6	493 - 603 Nm

### Connector

Model Number	Connector	Qty.	Remarks
LSVHG-*EH -*-*1	6 + PE Electrical Plug	1	Compatible with EN 175201 PART 804
LSVHG-*EH -*-*2	11 + PE Electrical Plug	1	

## Electrical Specifications

### 6 + PE Connector

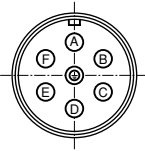

Pin		Valve Model	LSVHG- *EH- * -A1	LSVHG- *EH- * -B1	LSVHG- *EH- * -C1
		LSVHG- *EH- * -D1	LSVHG- *EH- * -E1	LSVHG- *EH- * -F1	
Pin A	Power Supply	24 V DC (21.6 - 26.4 V DC Included Ripple), 50 VA or more			
Pin B		0 V			
Pin C	Signal Common	COM (0 V)			
Pin D	Input (+) (Differential) <sup>★1</sup>	0 - ±10 V	4 - 20m A	0 - ±10 mA	
Pin E	Input (-) (Differential) <sup>★1</sup>	R <sub>i</sub> = 100 kΩ	R <sub>i</sub> = 200 Ω	R <sub>i</sub> = 200 Ω	
Pin F	Spool Travel Monitoring	0 - ±10 V R <sub>L</sub> ≥ 10 kΩ	4 - 20 mA R <sub>L</sub> = 100 - 500 Ω <sup>★2</sup>	0 - ±10 mA R <sub>L</sub> = 100 - 500 Ω <sup>★2</sup>	
Pin	Protective Earth	—			

### 11 + PE Connector

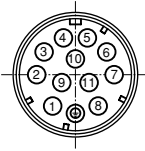

Pin		Valve Model	LSVHG- *EH- * -A2	LSVHG- *EH- * -B2	LSVHG- *EH- * -C2
		LSVHG- *EH- * -D2	LSVHG- *EH- * -E2	LSVHG- *EH- * -F2	
Pin 1	Power Supply	24 V DC (21.6 - 26.4 V DC Included Ripple), 50 VA or more			
Pin 2		0 V			
Pin 3	Enable (Servo ON) Input	Input Current = 3 - 5 mA at 4.8 - 28 V DC			
Pin 4	Input (+) (Differential) <sup>★1</sup>	0 - ±10 V	4 - 20 mA	0 - ±10 mA	
Pin 5	Input (-) (Differential) <sup>★1</sup>	R <sub>i</sub> = 100 kΩ	R <sub>i</sub> = 200 Ω	R <sub>i</sub> = 200 Ω	
Pin 6	Spool Travel Monitoring	0 - ±10 V R <sub>L</sub> ≥ 10 kΩ	4 - 20 mA R <sub>L</sub> = 100 - 500 Ω <sup>★2</sup>	0 - ±10 mA R <sub>L</sub> = 100 - 500 Ω <sup>★2</sup>	
Pin 7	Signal Common	COM (0 V)			
Pin 8	Valve Ready Output	Open Collector Output Voltage: Max. 30 V, Current: Max. 20 mA			
Pin 9 <sup>★3</sup>	Power Supply	24 V DC (21.6 - 26.4 V DC Included Ripple), 14 VA (Holding Current: 0.6 A)			
Pin 10 <sup>★3</sup>		(For Solenoid Operated Valve)	0 V		
Pin 11	Alarm Output	Open Collector Output Voltage: Max. 30 V, Current: Max. 20 mA			
Pin	Protective Earth	—			

★1. Differential input signals can be used only for the valves with the voltage signal specifications of ±10 V (LSVHG- \*EH-A\*/D\*).

★2. The recommended load resistance is 200 Ω.

★3. Pins 9 and 10 are used only for the valves with a fail-safe solenoid operated valve. In this case, use a separate power source for the solenoid operated valve from the power source for the amplifier (Pins 1 and 2).

### I/O Signal Characteristics

• LSVHG- \*EH- \* -A\*/B\*/C\*

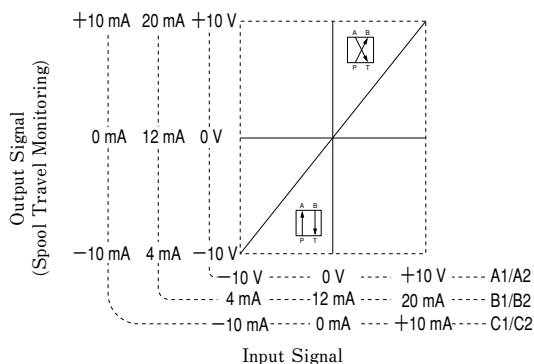

• LSVHG- \*EH- \* -D\*/E\*/F\*

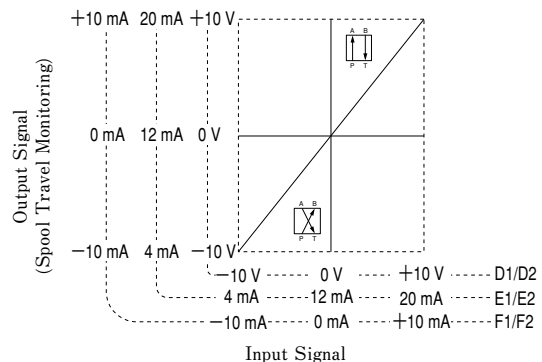

**LSVHG-06EH-900/1300**

Model Number	C	Remarks
LSVHG-06EH- * - *	244	Pilot Valve: Dry Type
LSVHG-06EH- * - *-W	253	Pilot Valve: Wet Type

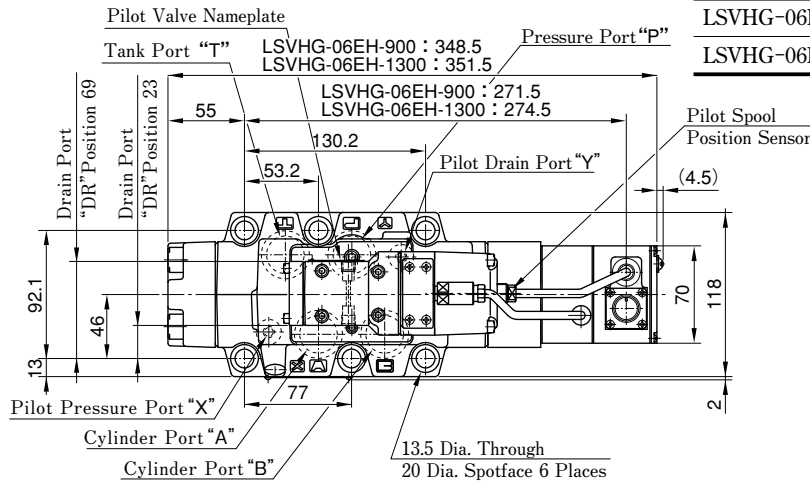

**External Connection Drain Port "DR"\***  
Rc 1/8 (Both Sides)  
Dry type pilot valve only.  
(Connect piping in such a way that negative pressure is avoided.)

Cable Applicable:  
Outside Dia. 8 - 10 mm

6 + PE/11 + PE Electrical Plug  
EN175201 Part 804

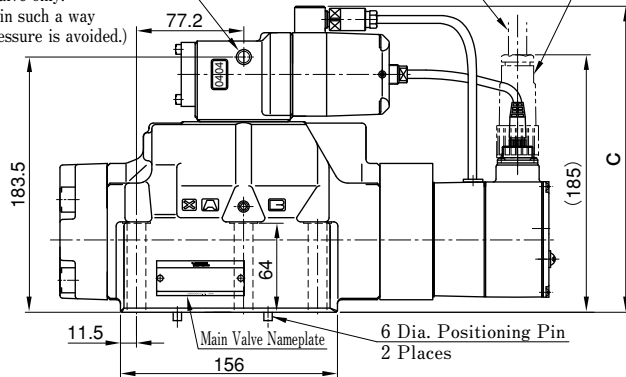

Color	Indicator Lamp
Green	Power Supply
Red	Pilot Valve Deviation Alarm
Yellow	Main Valve Deviation Alarm

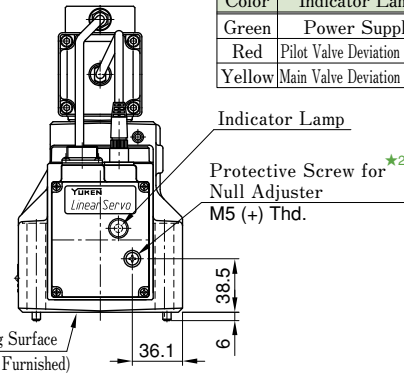

- ★1. The external connection drain port "DR" on the back side is usually plugged. To use the port on the back side, remove the hexagon socket head plug (Hex. 5) and plug the port on the front side.
- ★2. To adjust the null, remove the protective screw and turn the null trimmer. After adjustment, be sure to attach the protective screw.

**LSVHG-06EH-900/1300- \* - \* EA/EB/EC (With Fail-safe Solenoid Operated Valve)**

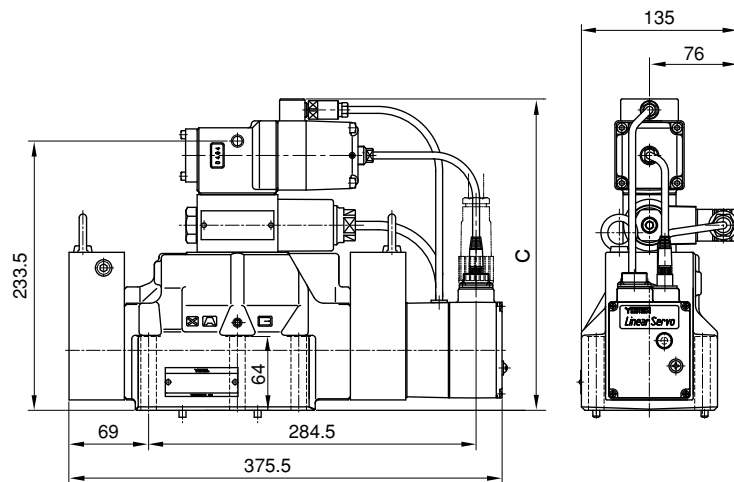

**Detailed Graphic Symbol**

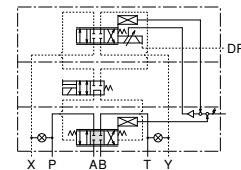

⊗ : Plugs for selecting the pilot and drain types

Note) The configuration in the shaded area varies with the selected spool type (corresponding to Graphic Symbols on page 30).

Model Number	C	Remarks
LSVHG-06EH- * - *-E *	270	Pilot Valve: Dry Type
LSVHG-06EH- * - *-WE *	279	Pilot Valve: Wet Type

● For other dimensions, see the figures above (the models without a fail-safe solenoid operated valve).

● O-rings for the Ports

Port	O-ring Size		Qty.
	LSVHG-06EH-900	LSVHG-06EH-1300	
P, A, B, T	AS568-123 (NBR, Hs90)	AS568-126 (NBR, Hs90)	4
X, Y	JIS B2401-1B-P14		2

O-rings made of fluorinated rubber are required to use phosphate ester type fluids.

**[Dimensions of Mounting Surface]**

The dimensions of the mounting surface are the same as those of the models LSVHG-06 (page 12).



## Characteristics of LSVHG-06EH-1300-2/40/2P (Fluid Viscosity: 30 mm<sup>2</sup>/s)

### No-Load Flow Characteristics

<Conditions> ● Valve Pressure Difference: 1 MPa (Pressure Difference per Land: 0.5 MPa)  
 Around Null Position Input Signal -20 ⇔ +20 %

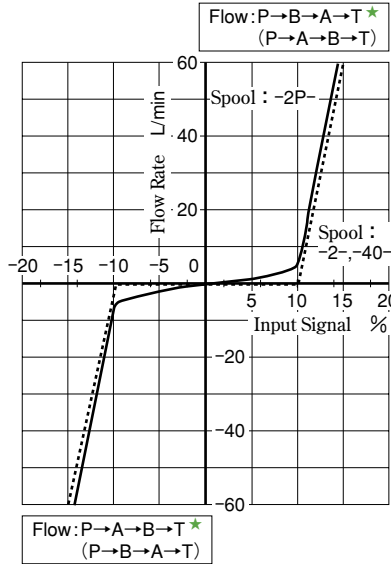
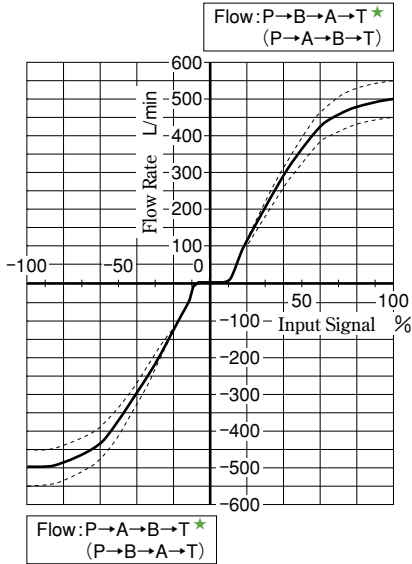

### Load Flow Characteristics

<Conditions> ● Input Signal : 100 %  
 Note) Tolerance for Load Flow : ±10 %

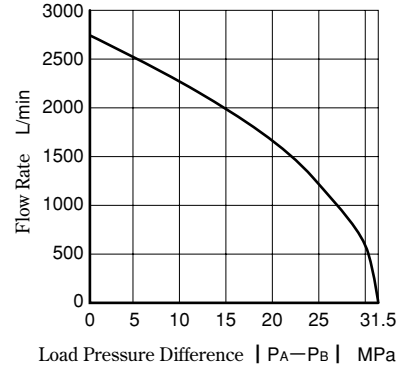

★ The flow outside of parentheses is achieved when the input signal type "A", "B", or "C" is selected. The flow in parentheses is achieved when "D", "E", or "F" is selected.

### Step Response

<Conditions> ● Input Signal : 0 ⇔ 100 % ● Supply/Pilot Pressure : 14 MPa

#### ● Pilot Valve: Dry Type

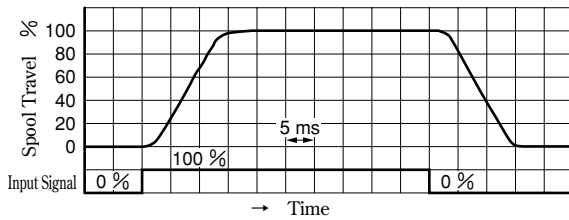

#### ● Pilot Valve: Wet Type

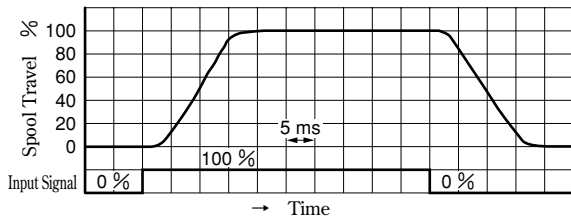

### Frequency Response

<Conditions> ● Hydraulic Circuit: Port A/B Closed ● Supply/Pilot Pressure : 14 MPa

#### ● Pilot Valve: Dry Type

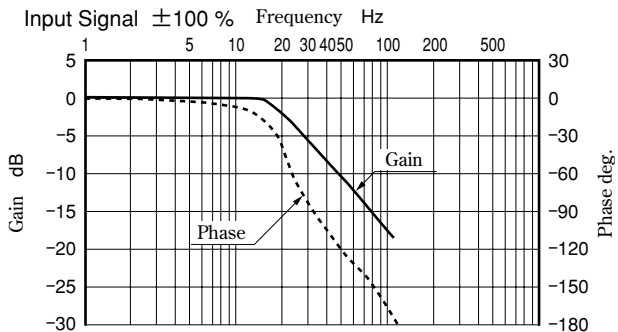
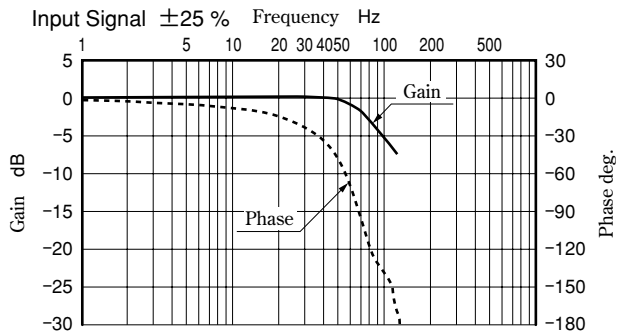

#### ● Pilot Valve: Wet Type

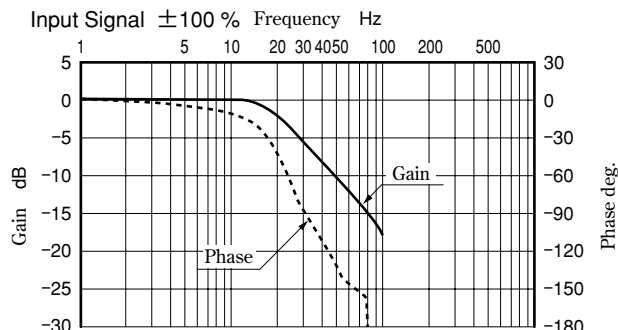
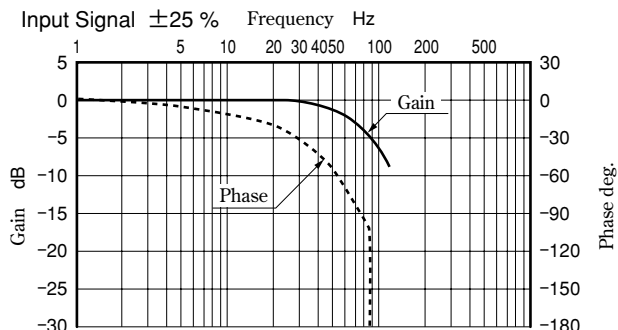

## Characteristics of LSVHG-10EH-3800-2/40/2P (Fluid Viscosity: 30 mm<sup>2</sup>/s)

### No-Load Flow Characteristics

<Conditions> ● Valve Pressure Difference: 1 MPa (Pressure Difference per Land: 0.5 MPa)

Around Null Position Input Signal -20 ⇔ +20 %

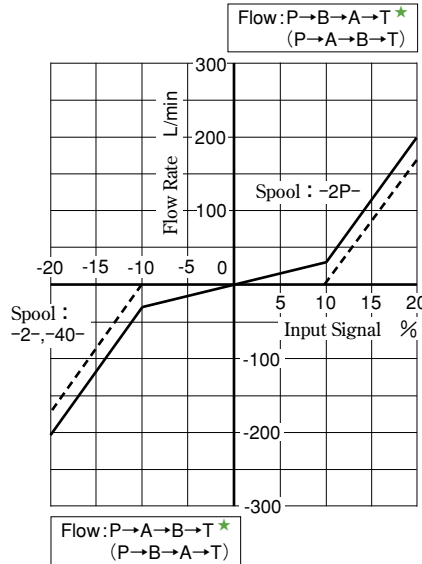
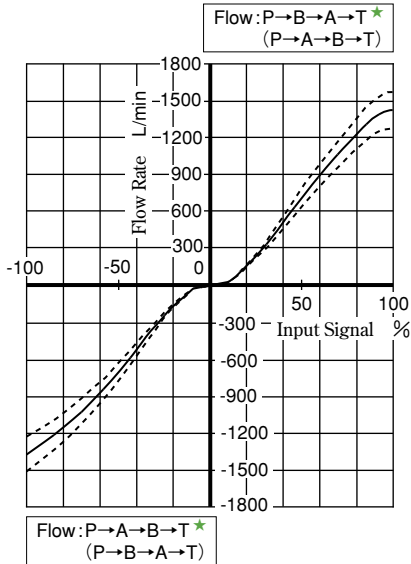

### Load Flow Characteristics

<Conditions>

● Input Signal : 100 %

Note) Tolerance for Load Flow : ±10 %

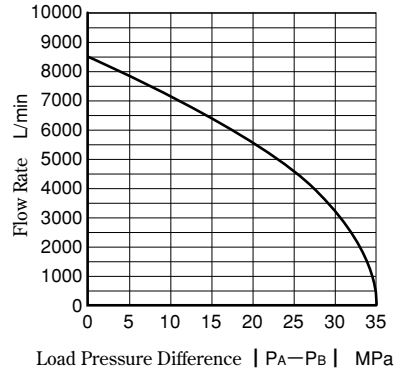

★ The flow outside of parentheses is achieved when the input signal type "A", "B", or "C" is selected. The flow in parentheses is achieved when "D", "E", or "F" is selected.

### Step Response

<Conditions> ● Input Signal : 0 ⇔ 100 % ● Supply/Pilot Pressure : 14 MPa

● Pilot Valve: Dry Type

● Pilot Valve: Wet Type

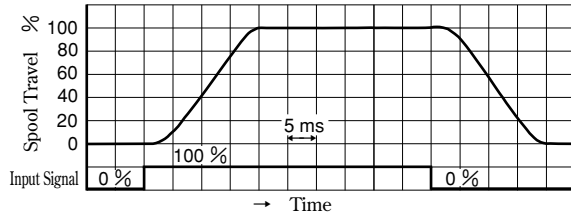
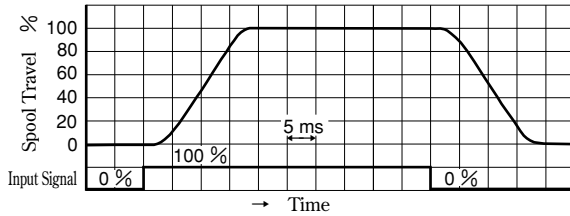

### Frequency Response

<Conditions> ● Hydraulic Circuit: Port A/B Closed ● Supply/Pilot Pressure : 14 MPa

● Pilot Valve: Dry Type

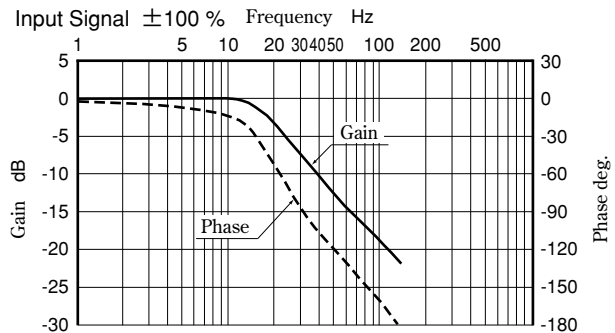
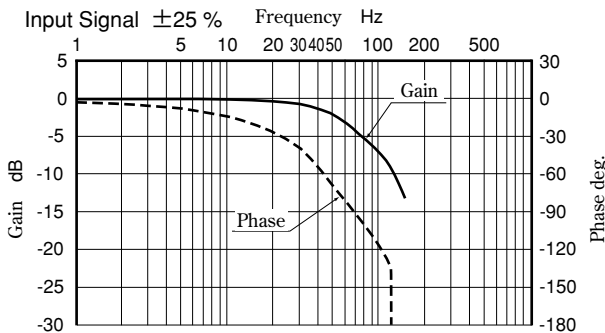

● Pilot Valve: Wet Type

